

# Battery Powered Smoke Alarms Ei650 Series



Read and retain carefully for as long as the product is being used. It contains vital information on the operation and installation of your Smoke Alarm. The leaflet should be regarded as part of the product.

If you are just installing the unit, the leaflet must be given to the householder. The leaflet is to be given to any subsequent user.

**Table 1**

<b>Standard <sup>1</sup></b>			
<b>Model</b>	<b>Hardwired Interconnect</b>	<b>RF <sup>3</sup> Capability</b>	<b>Optional RF Module Model No.</b>
<b>Ei650</b>	<b>No</b>	<b>No</b>	
<b>Ei650C</b>	<b>Yes</b>	<b>Yes</b>	<b>Ei600MRF</b>
<b>Ei650W</b>	<b>No</b>	<b>Yes</b>	<b>Ei600MRF</b>
<b>Intelligent <sup>2</sup></b>			
<b>Model</b>	<b>Hardwired Interconnect</b>	<b>RF Capability</b>	
<b>Ei650i</b>	<b>No</b>	<b>No</b>	
<b>Ei650iC</b>	<b>Yes</b>	<b>Yes</b>	<b>Ei600MRF</b>
<b>Ei650iW</b>	<b>No</b>	<b>Yes</b>	<b>Ei600MRF</b>

1. See table 2 for standard features and operation

2. See table 3 for intelligent features and operation

3. Certain Alarms may be supplied (on request) with the appropriate RF module fitted

# CONTENTS

Page

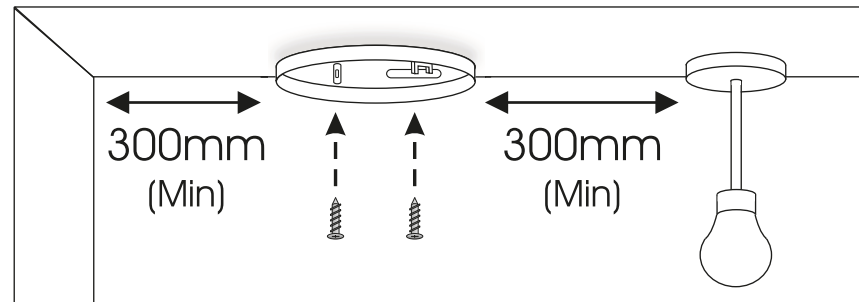
1	<b>QUICK START GUIDE</b>	4
2	<b>LOCATION &amp; POSITIONING</b>	6
3	<b>INSTALLATION</b>	12
4	<b>INTERCONNECTION - HARD WIRED</b>	16
5	<b>TESTING, MAINTENANCE &amp; POWER SUPPLY MONITORING</b>	18
6	<b>FIRE SAFETY ADVICE</b>	23
7	<b>SMOKE ALARM LIMITATIONS</b>	26
8	<b>RADIOLINK MODULES</b>	27
9	<b>GETTING YOUR ALARM SERVICED</b>	28
10	<b>FIVE YEAR GUARANTEE</b>	28
11	<b>TROUBLESHOOTING</b>	29
12	<b>Ei650 ALARM INDICATORS</b>	30
13	<b>Ei650i ALARM INDICATORS</b>	31
14	<b>CONTACT US</b>	40

# 1. Quick Start Guide

**1**

**LOCATE CORRECT SITING POINT**

**FIX BASEPLATE TO CEILING**

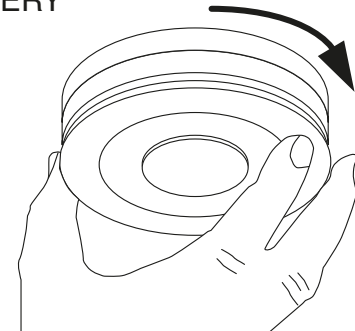
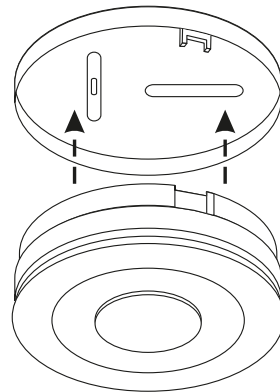


ALARM SHOULD BE CEILING MOUNTED AT LEAST 300MM FROM WALLS & OBSTRUCTIONS, IDEALLY CENTRALLY IN ROOM/AREA

**2**

**PLACE ALARM & TWIST ON TO BASE**

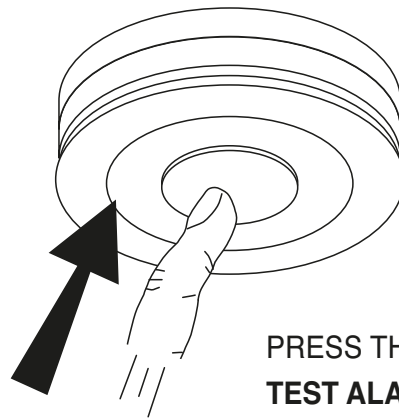
TWISTING THE UNIT ON TO THE BASE AUTOMATICALLY CONNECTS THE BATTERY



## Quick Start Guide

**3**

**TEST ALARM**



PRESS THE TEST BUTTON  
TEST ALARM AT LEAST WEEKLY

## 2. Location & Positioning

### Introduction

Congratulations on purchasing an Ei650 Series Alarm. You can easily install these Smoke Alarms throughout the property on escape routes, on each storey, in corridors & in closed rooms to give warning of fire.

Models Ei650C and Ei650iC can be interconnected with hard wiring (or RadioLINK plug-in modules) to give the loudest alarm sound level throughout the house. For wireless interconnection add the RadioLINK plug-in module (This module must be purchased separately).

Models Ei650W and Ei650iW can be wirelessly interconnected by adding the RadioLINK plug-in module (This module must be purchased separately).

Models Ei650 and Ei650i are stand alone Smoke Alarms and cannot be interconnected by either hardwire or RadioLink modules.

**Note:** Certain Smoke Alarms may be supplied (on request) with the appropriate RF module fitted.

### SMOKE ALARMS - Ei650 Series

Sufficient smoke must enter your Smoke Alarm before it will respond. Your Smoke Alarm needs to be within 7.5 metres of the fire to respond quickly. Smoke Alarms also need to be in positions where they can be heard throughout the property, so they can wake you and your family in time for everyone to escape. A single Smoke Alarm will give some protection if it is properly installed, but most homes will require two or more (preferably interconnected) to ensure that a reliable early warning is given. For recommended protection you should put individual Smoke Alarms in all rooms where fire is most likely to break out (apart from the kitchen and bathroom).

Your first Smoke Alarm should be located between the sleeping area and the most likely sources of fire (living room for example), but it should not be more than 7.5 metres from the door to any room where a fire may start and block your escape from the house.

### **Multi-Storey Dwellings**

If your home has more than one floor, at least one Smoke Alarm should be fitted on each level (see Figure 1). Preferably the Smoke Alarms should be interconnected so as to give sufficient warning throughout the property. RadioLINK plug-in modules are ideal in this situation as the Smoke Alarms will then interconnect using Radio Frequency (RF) signals - so no wiring is required.

Figure 1 illustrates where Smoke Alarms and Heat Alarms should be located in a typical two storey house. Note the spacings as given in figures 1&2 which ensure the early detection of fire and that the warning will be heard.

For additional protection, locate Heat Alarms in rooms adjoining escape routes - kitchens, garages, boiler houses etc. where Smoke Alarms are unsuitable. Install within 5.3m of potential sources of fire.

### **Single Storey Dwelling**

If the premises is one storey you should put your first Smoke Alarm in a corridor or hallway between the sleeping and living areas. Place it as near to the living area as possible, but make sure that it can be heard loudly enough in the bedroom to wake someone. See Figure 2 for placement example.

In houses with more than one sleeping area, Smoke Alarms should be placed between each sleeping area and the living area and it is recommended that Heat Alarms should be placed in the kitchen & garage.

## **Recommended Protection**

Fire authorities recommend you put individual Smoke Alarms in or near all rooms where fire is most likely to break out (apart from the locations to avoid e.g kitchens & bathrooms - see Section 3). The living room is the most likely place for a fire to start at night, followed by the kitchen (where a Heat Alarm is recommended) and then the dining room. Consideration should be given to installing Smoke Alarms in any bedrooms where fires might occur, for instance, where there is an electrical appliance such as an electric blanket or heater, or where the occupant is a smoker. In addition, consideration should be also given to installing Smoke Alarms in any rooms where the occupant is unable to respond very well to a fire starting in that room, such as an elderly or sick person or a very young child.

## **Checking Smoke Alarms Can Be Heard**

With the Smoke Alarms sounding in their intended locations check that the alarm can be heard in each bedroom with the door closed, above the sound of any TV/audio systems. The TV/audio systems should be set to a reasonably loud conversation level. If you cannot hear the alarm over the sound of the TV/audio system, the chances are it would not wake you. Interconnecting the Smoke Alarms using either a hard-wired interconnection (where the feature is present) or RadioLINK plug-in modules will help to ensure that the alarm will be heard throughout the property.

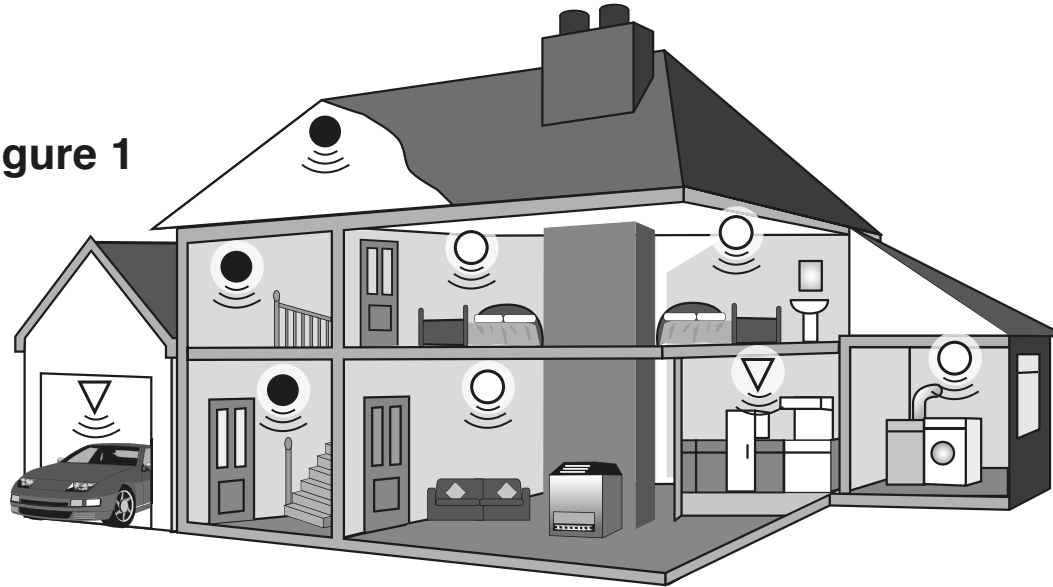
## **Positioning**

### **Ceiling Mounting**



Hot smoke rises and spreads out, so a central ceiling position is the recommended location. The air is “dead” and does not move in corners, therefore Smoke Alarms must be mounted away from corners. Keep at least 300mm from walls and corners



**Figure 1**





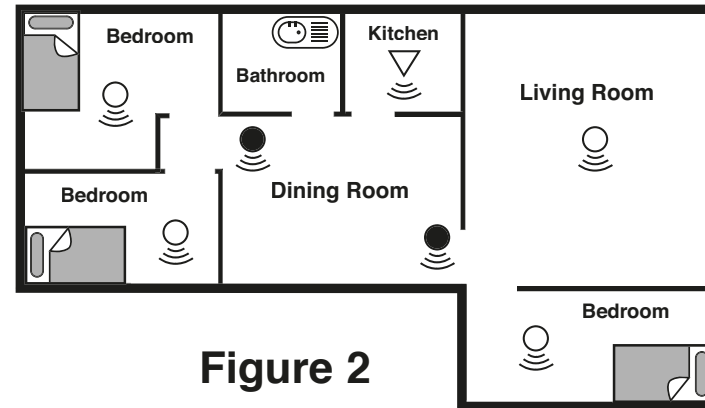
**For minimum protection**

-  - Smoke Alarm on each storey
-  - every 7.5 metres of hallways and escape routes
- within 3 metres of all bedroom doors
- all Alarms interconnected (where feature is present)

**For recommended protection**

(in addition to the above):

-  - Smoke Alarms in every room (except kitchens and bathrooms)
-  - Heat Alarms located in kitchens, garages etc. within 5.3m of potential fire sources



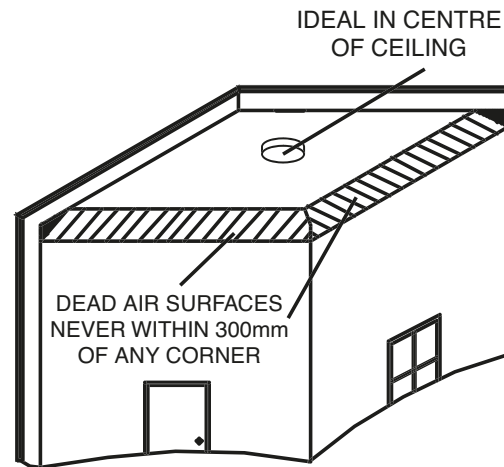
**Figure 2**

(see Figure 3). Additionally, mount the alarm at least 300mm from any light fitting or decorative object which might prevent smoke entering the Smoke Alarm.

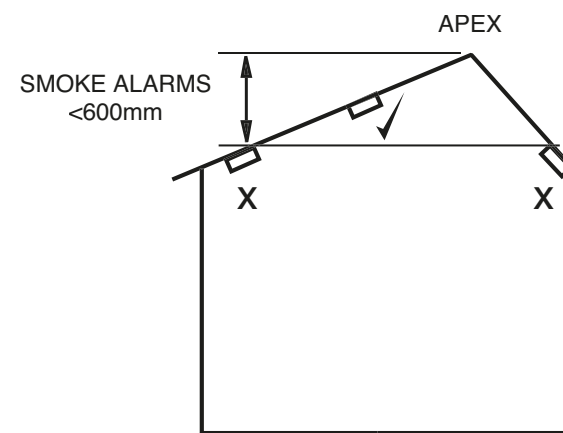
We do not recommend wall mounting of Smoke Alarms.

### On a Sloping Ceiling

With a sloping or peaked ceiling install a Smoke Alarm within 600mm of the peak (measured vertically). If this height is less than 600mm it is regarded as being flat (see **Figure 4**).



**Figure 3**



**Figure 4**

## **Locations to avoid**

### **DON'T place Smoke Alarms in any of the following areas:**

- Bathrooms, kitchens, shower rooms, garages or other rooms where the smoke alarm may be triggered by steam, condensation, normal smoke or fumes. Keep at least 6 metres away from sources of normal smoke/fumes.
- Locate away from very dusty or dirty areas as dust build-up in the chamber can impair performance. It can also block the insect screen mesh and prevent smoke from entering the smoke detector chamber.
- Do not locate in insect infested areas. Small insects getting into the smoke detector chamber can cause intermittent alarms.
- Places where the normal temperature can exceed 40°C or be below 0°C (e.g. attics, furnace rooms, directly above ovens or kettles etc.) as the heat/steam could cause nuisance alarms.
- Near a decorative object, door, light fitting, window moulding etc., that may prevent smoke or heat from entering the Alarm.
- Surfaces that are normally warmer or colder than the rest of the room (e.g. attic hatches). Temperature differences might stop smoke or heat from reaching the alarm.
- Next to or directly above heaters or air conditioning vents, windows, wall vents etc. that can change the direction of airflow.
- In very high or awkward areas (e.g. over stairwells) where it may be difficult to reach the Alarm (for testing & hushing).
- Locate the Alarm at least 1m from dimmer controlled lights and wiring as some dimmers can cause interference.

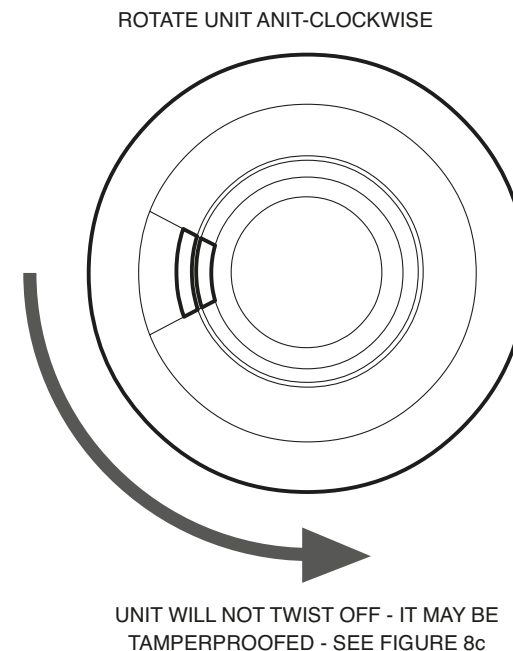
- Locate alarm at least 1.5m and route any interconnected wiring at least 1m away from fluorescent light fittings as electrical “noise” and/or flickering may affect the Alarm.

### 3. Installation

#### Installation Procedure

1. Select a location complying with the advice in Section 2.
2. Remove the mounting plate from the Smoke Alarm by twisting it in an anti-clockwise direction (see Figure 5).
3. Place the mounting plate on the ceiling exactly where you want to mount the Alarm. With a pencil, mark the location of the two screw holes.
4. If interconnecting Smoke Alarms using hard-wired connections, run suitable twin core cabling to the marked locations of each Alarm. Make the connections to the Alarm (see Section 4).
5. Taking care to avoid any electrical wiring in the ceiling, drill holes using a 5.0mm drill bit through the centre of the marked locations. Push the plastic screw anchors provided into the drilled holes. Screw the mounting plate to the ceiling.

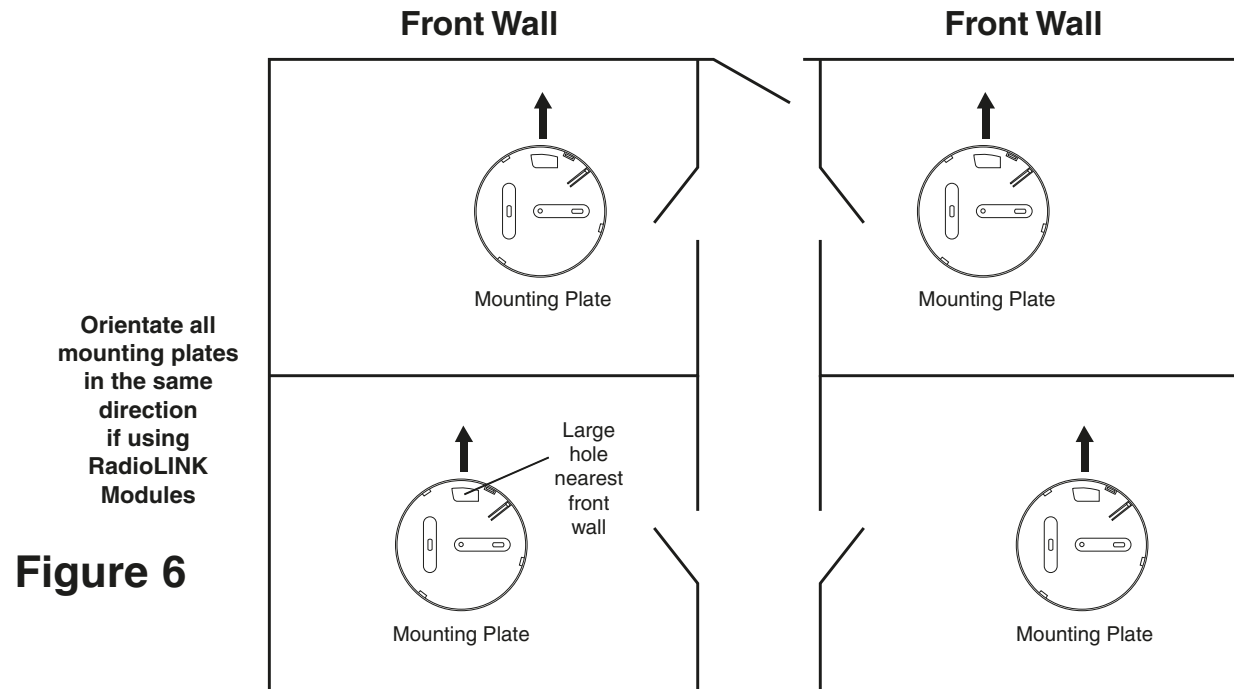
If using RadioLINK Smoke Alarms then they should be mounted with antennas in the same orientation (i.e. essentially parallel). This means



**Figure 5**

picking a part of the building, say the front wall of the building and then installing all mounting plates in the same orientation with respect to this (see figure 6).

6. Carefully line up the Alarm on the base, gentle press home & twist on.



Install all the other Smoke Alarms similarly.

7. Press the Test button on each Alarm to ensure that it sounds (see Figure 7).

8. For hard-wired interconnected Smoke Alarms - see section 4.

9. If using RadioLINK interconnection, see the 'RadioLINK Module Booklet'.

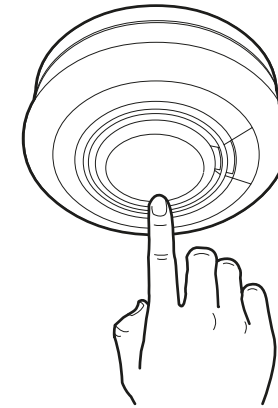
Install all the other Smoke Alarms similarly.

### **Tamperproofing the Smoke Alarms**

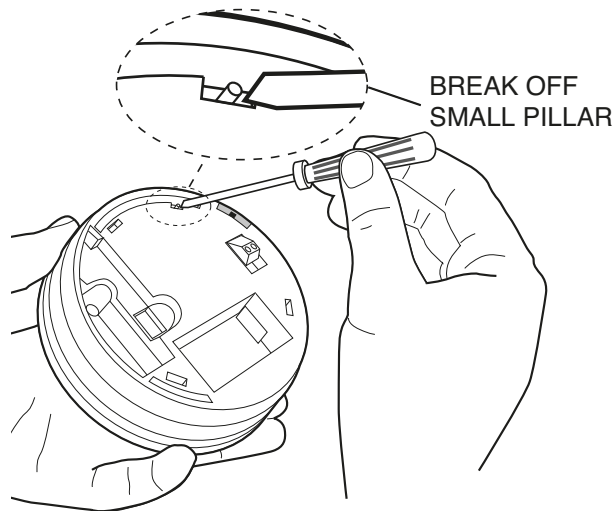
The Alarm can be made tamperproof to prevent unauthorised removal.

Break off the small pillar on the base as shown in figure 8a.

To remove the Alarm from the ceiling it is now necessary to use a small screwdriver. To release the Alarm, push the catch towards the ceiling and then twist off (see figure 8b).

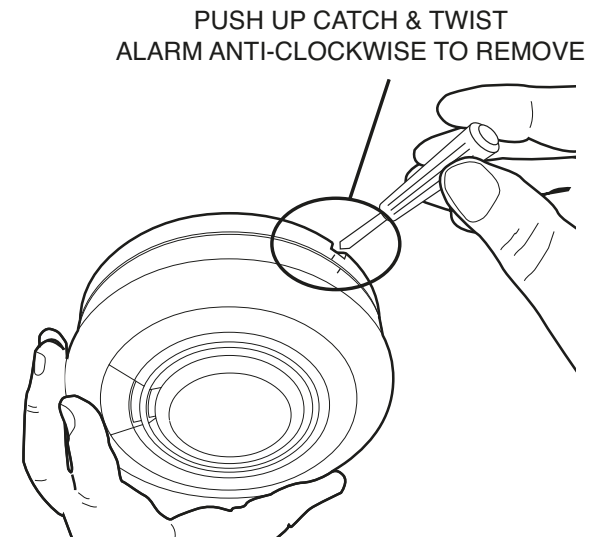


**Figure 7**



How to Tamperproof

**Figure 8a**

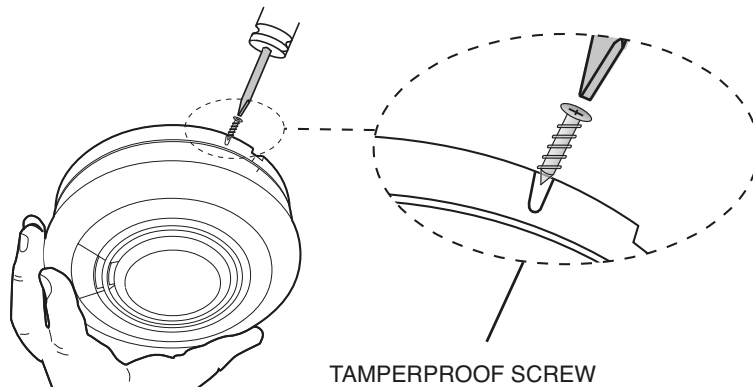


How to Remove

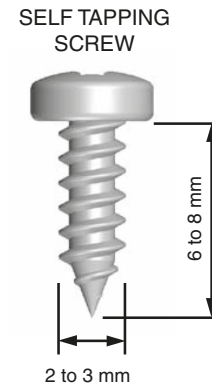
**Figure 8b**

If necessary, it is possible to further secure the Alarm by using a No.2 or No.4 (2 to 3 mm diameter - *not supplied*) self tapping screw 6 to 8mm long (see figure 8d), to firmly lock the Alarm and its mounting plate together (see figure 8c).

First, attach the Alarm to the mounting plate.



**Figure 8c**



**Figure 8d**

Line up the screw (not supplied) on the “U” shaped recessed area shown in figure 8c and screw firmly home.

To remove the Alarm from the ceiling, remove the screw first, and then twist off anti-clockwise.

## 4. Interconnection - Hard Wired

A combined maximum of 12 Smoke Alarms and/or Heat Alarms may be wired together such that when one Alarm senses fire all other Alarms sound a warning - (see Table 1 for the Smoke Alarms with the hardwired interconnect option). This helps ensure the alarm will be heard throughout the property.

Do not connect to any other device as it may damage the Alarm or affect performance.

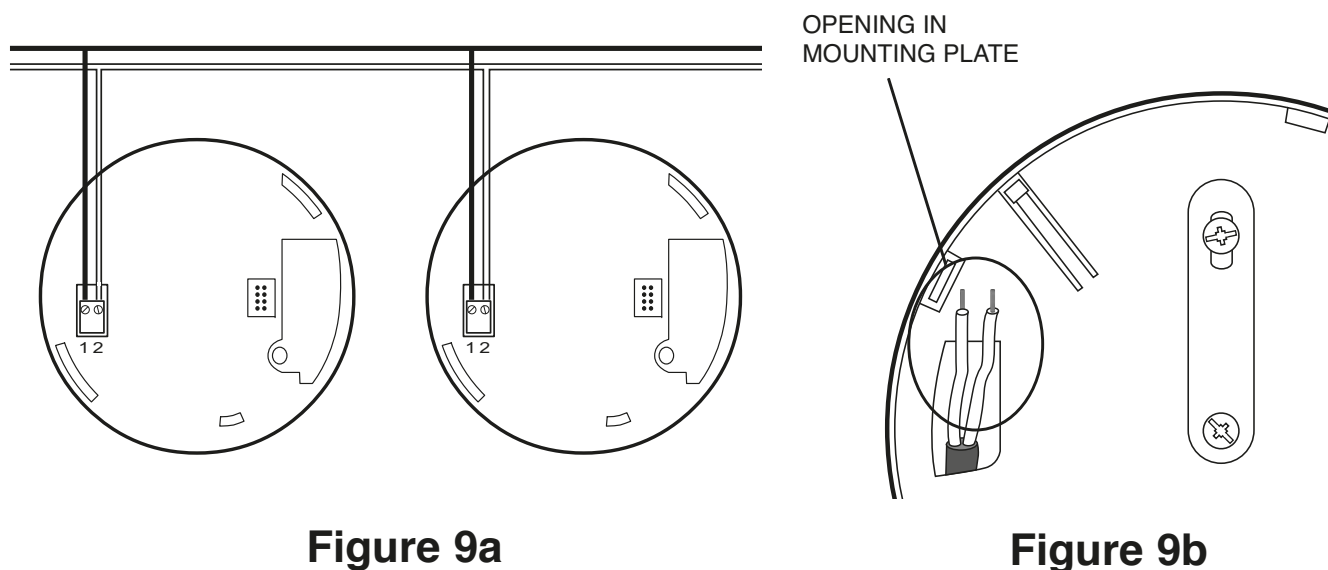


Figure 9a

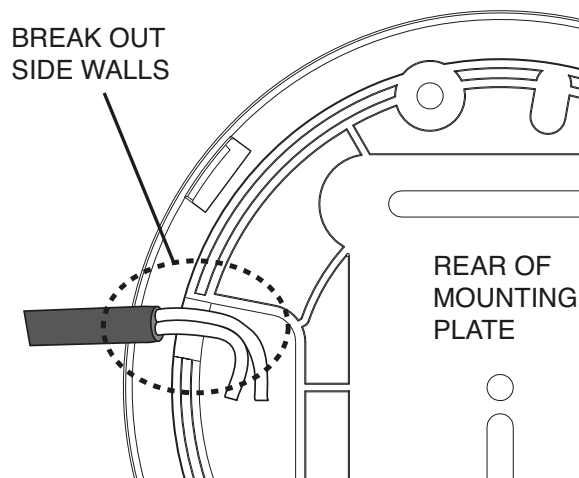
Figure 9b

A maximum of 250 metres of two core,  $0.5\text{mm}^2$  to  $0.75\text{mm}^2$ , stranded signal cable can be used, (maximum resistance between detectors 50 ohm). The Alarms are interconnected by wiring all the terminals marked 1 together, and all the terminals marked 2 together (see in Figure 9a). Note: Draughts from wiring openings, conduit, or mounting boxes/holes, may blow smoke away from the sensing chamber,

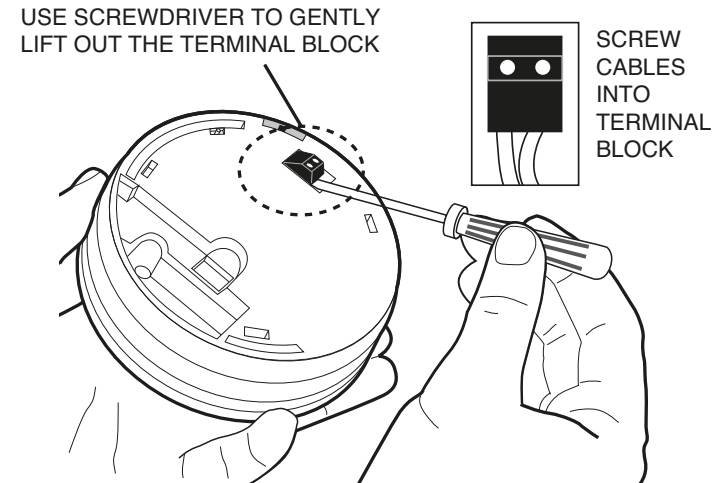


making it insensitive. It is essential that all such ceiling openings be closed with silicone sealant or similar.

1. Run the two core cable to the Alarm locations.
2. Bring the cable through the opening in the mounting plate (before screwing it to the ceiling) see figure 9b.
3. If you are bringing the wiring along the surface, break out the two notches (see figure 10a).
4. Using a small screwdriver, lift off the terminal block by raising it vertically (see figure 10b).
5. Screw the two cable cores into the terminal block (see figure 10b). Then carefully press the terminal block back on to the two pins in the base.



**Figure 10a**



**Figure 10b**

6. Twist the Alarm clockwise on to the mounting plate to lock in place.

Install and connect all the other Alarms similarly.

Now test the first Alarm by pressing and holding the Test button (this may take up to 5 seconds). The red indicator light will flash about once every 0.5 seconds and all Alarms should sound (note: when the test button is released the local Smoke Alarm will stop sounding but the interconnected Alarms will continue to sound for a further 3 seconds. This allows one person to check the Alarms are interconnected). Test all the other Alarms similarly.

Note: These Alarms should be interconnected only within the confines of a single family living unit. If they are connected between different residences there may be excessive nuisance alarms. Everybody may not be aware that they are being tested or that it is a nuisance alarm caused by cooking etc.

## 5. Testing, Maintenance & Power Supply Monitoring

Your Smoke Alarm is a life saving device and should be checked periodically.

### 5.1 Manually Testing your Smoke Alarms

It is recommended that you test your Smoke Alarms after installation and then at least monthly to ensure they are working. It will also help you and your family to become familiar with the sound of the Alarms.

- Press and hold the Test Button until the Alarm sounds and the red light flashes (see Figure 7). The Alarm will stop sounding shortly after the button is released.
- If the Smoke Alarms are interconnected using hard-wired connections, check that all interconnected Alarms sound.

- If they are interconnected using RadioLINK modules, hold down the Test button until the blue light on the cover of the Alarm illuminates. Check that all other Alarms sound.
- Release the Test button. The Alarm and all connected Alarms should stop sounding.
- Repeat this procedure for all other Alarms in the system.

**WARNING: Do not test with flame.**

This can set fire to the Alarm and damage the house. We do not recommend testing with smoke as the results can be misleading unless special apparatus is used.

When you press the Test button it simulates the effect of smoke in a Smoke Alarm which it could experience in a real fire. So, there is no need to test it with smoke.

## **5.2 Test/Hush Button to Control Nuisance alarms**

The Smoke Alarms have a combined Test/Hush button to help you control nuisance/false alarms.

When the Alarm sounds and there is no sign of smoke or noise to indicate that there is a fire, it should be assumed that it is due to an actual fire and the dwelling should be evacuated immediately.

Check the house carefully in case there is a small fire smouldering somewhere.

Check whether there is some source of smoke or fumes, for example cooking fumes being drawn past the Alarm by an extractor.

If there are frequent nuisance/false alarms it may be necessary to re-locate the Smoke Alarm away from the source of the fumes.

If you installed Smoke Alarms with RadioLINK modules and did not House Code them, you may be receiving alarm signals from a neighbouring system. This can be easily rectified by “House Coding” your Alarms - see the ‘RadioLINK Module Booklet’.

1. To cancel a false alarm from a Smoke Alarm (which has its red light flashing rapidly), press the Test/Hush button (the Smoke Alarm will automatically switch to a reduced sensitivity condition).

The Smoke Alarms will be silenced for a period of approximately 10 minutes. The red light on the cover of the Smoke Alarm will flash every 10 seconds (instead of 40 seconds) to indicate that the unit has been silenced.

2. The Smoke Alarm will reset to normal sensitivity at the end of the silenced period (10 minutes). If additional silenced time is required, simply push the Test/Hush button again.

3. If kitchen usage/layout is such that there are an unacceptable level of nuisance alarms, re-locate the Smoke Alarm further away where it will be less affected by cooking fumes etc. We recommend the use of a Heat Alarm in the Kitchen area to avoid such nuisance alarms.

## **5.3 Power Supply Monitoring**

### **5.3.1 What to do when an Alarm is beeping/flashing:**

**a)** If a Smoke Alarm is beeping about every 32 seconds with the red or yellow light flashing at the same time:

- This indicates that the Lithium Battery is partially depleted and the Smoke Alarm needs to be replaced. (check the “replace by” date marked on the side of the Alarm).

## 5.4 Cleaning your Alarm

Clean your Alarm regularly. Use the flat open end of your vacuum cleaner to remove dust and cobwebs from the side slots where the smoke enters. To clean the cover, wipe with a damp cloth and dry thoroughly.

### **WARNING: Do not paint your Alarm.**

Other than the maintenance and cleaning described in this leaflet, no other customer servicing of this product is required. Repairs, when needed, must be performed by the manufacturer.

## 5.5 Smoke Alarm Automatic Self-Test

The smoke chamber in the Smoke Alarms automatically tests itself every 16 seconds.

**Ei650, Ei650C & Ei650W models:** If the chamber is degraded it will beep twice every 32 seconds coinciding with 2 red flashes. (See indicator summary in section 12).

**Ei650i, Ei650iC & Ei650iW models:** If the chamber is degraded it will beep twice every 32 seconds coinciding with 2 yellow flashes (See indicator summary in section 13).

If this happens clean the Alarm. If the beeping and flashing persists, return the Alarm for service (see section 9 – Getting your Smoke Alarm Serviced).

## 5.6 Dust & Insect Contamination

All Smoke Alarms and particularly the optical (photoelectric) type are prone to dust and insect ingress which can cause false alarms.

The latest design, materials and manufacturing techniques have been used in the construction of Ei Electronics Alarms to minimise the effects of contamination.

However it is impossible to completely eliminate the effect of dust and insect contamination, and therefore, to prolong the life of the Alarm you must ensure that it is kept clean so that excess dust does not build up. Any insects or cobwebs in the vicinity of the Smoke Alarm should be promptly removed. In certain circumstances even with regular cleaning, contamination can build up in the smoke sensing chamber causing the Alarm to sound. Contamination is beyond our control, it is totally unpredictable and is considered normal wear and tear. For this reason, contamination is not covered by the guarantee and a charge is made for all such servicing work.

### **5.7 Smoke Alarm Replacement**

The entire Alarm must be replaced if:-

- The Alarm is installed for over 10 years (check the “replace by” date marked on the side of the Alarm).
- If the Smoke Alarm is giving a low battery indication - i.e. a short beep with a simultaneous red or yellow light flash every 32 seconds. (Note: for an *iSeries* Alarm, if it is not convenient to replace it immediately, pressing the test button will silence the beeps and stop the yellow LED flashing for 12 hours. This can be repeated as required).
- The Alarm fails to sound the horn loudly when the test button is pressed.

Before the Alarm is safely discarded, remove from the mounting plate (to unpower the Alarm and to stop low battery beeps).

#### **Do not put the Alarm into a fire.**

The Alarm should be disposed in a safe and environmentally sound manner at your local recycle centre. Contact your local authority for further advice.

## 6. Fire Safety Advice

When using household protective devices, basic safety precautions should always be followed, including those listed below

- Please read all instructions.
- Rehearse emergency escape plans so everyone at home knows what to do in case the alarm sounds.
- Use the Alarm Test Button to familiarise your family with the Alarm sound and to practice fire drills regularly with all family members. Draw up a floor plan that will show each member at least 2 escape routes from each room in the house. Children tend to hide when they don't know what to do. Teach children how to escape, open windows, and use roll up fire ladders and stools without adult help. Make sure they know what to do if the alarm goes off.
- Constant exposure to high or freezing temperatures, high humidity or a high level of nuisance alarms may reduce the life of the battery.
- Nuisance alarms can be quickly silenced by fanning vigorously with a newspaper or similar to remove the smoke or press the test / hush button.
- Do not attempt to remove, recharge or burn the battery, as it may explode.
- To maintain sensitivity to smoke, do not paint or cover the Alarm in any manner; do not permit any accumulation of cobwebs, dust or grease.
- If the Alarm has been damaged in any way or does not function properly, do not attempt a repair. Return the Alarm (see Section 9).
- This appliance is intended ONLY for premises having a residential type environment.

- This is not a portable product. It must be mounted following the instructions in this instruction leaflet.
- Smoke Alarms are not a substitute for insurance. The supplier or manufacturer is not your insurer.

### **Fire Safety Hints**

Store petrol and other flammable materials in proper containers.

Discard oily or flammable rags.

Always use a metal fireplace screen and have chimneys cleaned regularly.

Replace worn or damaged sockets, switches, home wiring and cracked or frayed electrical cords and plugs.

Do not overload electrical circuits.

Keep matches away from children.

Never smoke in bed. In rooms where you do smoke, always check under cushions for smouldering cigarettes and ashes.

Service central heating systems regularly.

Be sure all electrical appliances and tools have a recognised approval label.



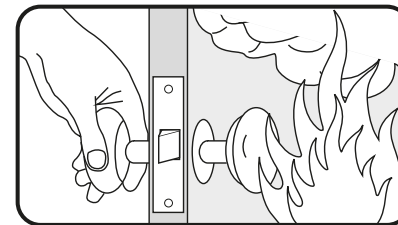
This device cannot protect all persons at all times. It may not protect against the three most common causes of fatal fires:

1. Smoking in bed.
2. Leaving children at home alone.
3. Cleaning with flammable liquids, such as petrol.

Further information can be obtained from the Fire Brigade.

### **Planning Your Escape Route For When The Smoke Alarms Sound**

1. Check room doors for heat or smoke. Do not open a hot door. Use an alternate escape route. Close doors behind you as you leave.



2. If smoke is heavy, crawl out, staying close to floor. Take short breaths, if possible, through a wet cloth or hold your breath. More people die from smoke inhalation than from flames.



3. Get out as fast as you can. Do not stop for packing. Have a prearranged meeting place outside for all family members. Check everybody is there.



4. Call the Fire Brigade from a neighbour's house or mobile phone. Remember to give your name and address.



5. **NEVER** re-enter a burning house.



## 7. Alarm Limitations

### Limitations of Smoke Alarms

Smoke Alarms have significantly helped to reduce the number of fire fatalities in countries where they are widely installed. However independent authorities have stated that they may be ineffective in some circumstances. There are a number of reasons for this:

- Smoke Alarms will not work if the batteries are depleted or if they are not connected. Test regularly and replace the entire Alarm when it fails to operate.
- Smoke Alarms will not detect fire if sufficient smoke or heat does not reach the Alarm. Smoke may be prevented from reaching the Alarm if the fire is too far away, for example, if the fire is on another floor, behind a closed door, in a chimney, in a wall cavity, or if the prevailing air draughts carry the smoke or heat away. Installing Smoke Alarms on both sides of closed doors and installing more than one Alarm as

recommended in this leaflet very significantly improve the probability of early detection.

- The Smoke Alarm may not be heard.
- RadioLINK may not work due to interference or due to the signal being blocked by furniture, renovations etc.
- A Smoke Alarm may not wake a person who has taken drugs or alcohol.
- The Alarms may not detect every type of fire to give sufficient early warning. They are particularly ineffective with: fires caused by smoking in bed, escaping gas, violent explosions, poor storage of flammable rags and/or liquids, (for example petrol, paint, spirits etc), overloaded electrical circuits, arson, children playing with matches.
- Smoke Alarms don't last indefinitely. We recommend replacement after 10 years as a precaution.

## 8. RadioLINK Module

The RadioLINK Interconnect module plugs into the rear of the Alarm. This ensures that when one Alarm senses fire, all Alarms sound through-out the house.

## **9. Getting Your Alarm Serviced**

If your Alarm fails to work after you have read the sections on “Installation”, “Testing and Maintenance” and “Troubleshooting”, then contact Customer Assistance at the nearest address given at the end of this leaflet. If it needs to be returned for repair or replacement the Smoke Alarm must be removed from the mounting plate and put in a padded box. Send it to “Customer Assistance” at the nearest address given on the Alarm or in this leaflet. State the nature of the fault, where the Alarm was purchased and the date of purchase.

## **10. Five Year Guarantee**

Ei Electronics guarantees this Alarm for five years from date of purchase against any defects that are due to faulty materials or workmanship. This guarantee only applies to normal conditions of use and service, and does not include damage resulting from accident, neglect, misuse, unauthorised dismantling, or contamination howsoever caused. This guarantee excludes incidental and consequential damage. If this Alarm should become defective within the guarantee period, it must be returned to Ei Electronics, with proof of purchase, carefully packaged, with the problem clearly stated (see Section 9). We shall at our discretion repair or replace the faulty Alarm.

Do not interfere with the Alarm or attempt to tamper with it. This will invalidate the guarantee, but more importantly may expose the user to fire hazards.

This guarantee is in addition to your statutory rights as a consumer.

## 11. Troubleshooting

### **Smoke Alarms sound for no apparent reason**

- Check for fumes, steam, etc. from the kitchen or bathroom. Paint and other fumes can cause nuisance alarms.
- Check for any sign of contamination such as cobwebs or dust. Clean the Alarm as described in Section 5 if necessary.
- Press the Test/Hush button on the Smoke Alarm causing the alarm (this can be identified as the Alarm with the red light flashing rapidly) – this will silence the Smoke Alarm for 10 minutes (and also silence all other interconnected Smoke Alarms in the system).
- Smoke Alarms, with RadioLINK modules, sound for 2 seconds every 4 hours - this indicates that there is a depleted RF Module battery somewhere in the system - check all Alarms as outlined in the relevant section of the RF Module booklet.
- House Code your RadioLINK Alarms - see the 'RadioLINK Module Booklet'. If the Alarms are in the default factory settings, neighbouring Alarms may cause them to sound.

### **The Alarm fails to sound when the Test button is pressed**

- Check the age of the Alarm - see the “replace by” label on side of Alarm.
- Ensure the alarm is twisted fully home on the mounting plate, as this connects the battery.

## 12. Ei650 Alarm Indicators

Table 2 - Ei650 INDICATOR SUMMARY

Mode	RED LED	HORN / SOUNDER
<b>Normal</b>	Off	Off
Power Up	1 Flash	Off
Button Test (Weekly)	Rapid Flashing (every 0.5 sec)	Ramps to full sound
<b>When Fire Occurs</b>		
Unit Sensing Fire itself	Rapid Flashing (every 0.5 sec)	Full Sound
Sensing fire though interconnect	Off	Full Sound
<b>Nuisance Alarm</b>	Rapid Flashing (every 0.5 sec)	Full Sound
Press Button & Release	1 Flash every 8 secs for 10 mins	Off
<b>Low Battery</b>	1 Flash every 32 sec	1 beep with Flash
<b>Faulty Smoke Sensor</b>	2 Flashes every 32 sec	2 beeps with Flashes

## 13. Ei650i Alarm Indicators

**Table 3 - Ei650i INDICATOR SUMMARY**

<b>Normal Operation</b>	<b>Action</b>	<b>Red LED</b>	<b>Yellow LED</b>	<b>Sounder</b>	<b>See 12.1</b>	<b>Replace Alarm</b>
Power up	Twist on base	1 flash	1 flash	Off	12.1.1	
Standby		Off	Off	Off	12.1.2	
Weekly button test	Press & hold button	Rapid flashing (0.5 sec)	Off	Ramps to full sound	12.1.3	If test fails
Sensing Fire		Rapid flashing (0.5 sec)	Off	Full sound	12.1.4	
Silence False / Nuisance Alarm	Press & release button	1 flash every 8 seconds for 10 minutes	Off	Alarm Silence	12.1.5	If test fails
Fire signal from interconnect		Off	Off	Full sound	12.1.6	
<b>Fault Conditions</b>	<b>Action</b>	<b>Red LED</b>	<b>Yellow LED</b>	<b>Sounder</b>	<b>See 12.2</b>	<b>Replace Alarm</b>
<b>Low battery</b>		Off	1 flash every 32 seconds	1 beep with flash	12.2.1	Replace Alarm
Clear low battery fault	Press & release button	Off	Off for 12 hours	Off for 12 hours		Replace Alarm
<b>Contaminated chamber</b>		Rapid flashing (0.5 sec)	Off	Full sound	12.2.2	See note *
Silence sounding alarm	Press & release button	1 flash every 8 seconds	Off	Off for 10 minutes		
Silence sounding alarm (2nd time)	Press & release button within 4 minutes	1 flash every 8 seconds	Off	Off for an additional 10 minutes		
Silence sounding alarm (3rd time)	Press & release button within 4 minutes	2 flashes every 8 seconds	Off	2 rapid beeps every 10 minutes for 8 hours		Replace Alarm
<b>Faulty smoke chamber</b>		Off	2 flashes every 32 seconds	2 beeps with flashes	12.2.3	Replace Alarm
Silence beeps	Press & release button	Off	Off	Off for 12 hours		Replace Alarm

\*Note: We recommend to vacuum the alarm initially (incase of cobwebs etc) and allow 5 minutes before retest, if it still shows a problem, then replace.

**Table 3 - Ei650i INDICATOR SUMMARY (cont.)**

<b>Diagnostics Modes</b>	<b>Action</b>	<b>Red LED</b>	<b>Yellow LED</b>	<b>Sounder</b>	<b>See 12.3</b>	<b>Replace Alarm</b>
<b>Predictive failures</b>					12.3.1	
Low battery	Press & hold button	Off	Rapid flash (0.5 sec)	Ramps to full sound		Recommended
Contaminated chamber	Press & hold button	Rapid flash (0.5 sec) alternates with yellow	Rapid flash (0.5 sec) alternates with red	Ramps to full sound		See note
End of Life Test	Press & hold button	Rapid flash (0.5 sec) alternates with yellow	Rapid flash (0.5 sec) alternates with red	Off		Replace Alarm
<b>Alarm memory</b>					12.3.2	
24 hour memory		2 flashes every 16 seconds	Off	Off		
Long term memory	Press & hold button	Rapid flash (0.5 sec)	Off	Rapid chirping		
<b>Identifying beeping units</b>					12.3.3	
Low battery beep	Press & hold button	Off	Rapid flash (0.5 sec)	Ramps to full sound		Replace Alarm
Faulty smoke chamber	Press & hold button	Off	Rapid flash (0.5 sec)	Off		Replace Alarm



### **Table 3 Ei650i Indicators explained**

#### **12.1. Normal Operation**

##### **12.1.1. Power Up**

Twist the Alarm onto the base to power up, the red LED will flash once followed by one flash of the yellow LED to indicate that the Alarm has been powered successfully and is now in standby mode.

##### **12.1.2. Standby**

In standby mode there are no active visible or audible indications which can be intrusive to the householder. To confirm that the Alarm is operational perform a weekly button test.

##### **12.1.3. Weekly button test**

Press and hold the test button and verify that the red LED flashes rapidly and the Alarm ramps up to full sound.

##### **12.1.4. Sensing Fire**

As soon as the Alarm senses smoke it will go into alarm (along with any interconnected Alarms). The red LED on the Alarm sensing smoke flashes rapidly to indicate it is the Alarm sensing fire. Follow the instruction in section 6 and evacuate the building.

#### 12.1.5. Silence False / Nuisance alarm

Occasionally Smoke Alarms can be activated by phenomena other than fire, e.g. dust, insects, cooking fumes. Once you are sure it is a nuisance alarm press the large test button to silence the alarm for 10 minutes – the red LED will then flash every 8 seconds for 10 minutes.

#### 12.1.6. Interconnect system in alarm

With an interconnected system it is almost impossible, without a control switch, to locate the actual Alarm that has activated the system. In the case of a real fire, this is not a major concern as the occupiers of the dwelling should proceed in accordance with 12.1.4 above. However if the system is responding to a recurring nuisance alarm it is very important that the offending Alarm is identified so the problem can be eliminated by cleaning or replacing this Alarm. The offending Alarm can be identified by a rapidly flashing red LED. Once the offending Alarm has been located follow 12.1.5 above.

### **12.2. Fault Conditions**

#### 12.2.1. Low battery

Normally the battery will last over 10 years before it becomes partially depleted. Check the date when the Alarm should be replaced which is given on the sidewall of the Alarm. When electronic self testing indicates that the battery is becoming low the Alarm will beep and the yellow LED will flash at the same time (about every 32 seconds) to warn the user. This indicates that the Alarm must be replaced.

If it is not convenient to replace the Alarm immediately, then press the test button to silence the low battery beeps and stop the yellow LED flashing for 12 hours. This can be repeated as required.

#### 12.2.2. Contaminated chamber

If the Alarm sounds without any apparent smoke being present, press the test button to silence the Alarm for 10 minutes (as described in 12.1.5 above). If the Alarm sounds again it may be contaminated. Pressing the test button again, within 4 minutes of the Alarm re-sounding, will get the Alarm to compensate for chamber contamination. This will normally resolve the problem.

If the Alarm re-sounds for a third time, the Alarm is excessively contaminated and must be replaced. If it is not convenient to replace it immediately, pressing the test button within 4 minutes of it going into alarm (for the third time) will silence the Alarm for 8 hours – however it will give two short beeps (second apart) every 10 minutes to remind the user it has been disabled. If the contamination clears the Alarm will return to normal operation.

(Note: this does not reduce the users fire protection, as a Smoke Alarm in continuous alarm due to a fault, is useless and must be silenced – by taking the Alarm down or as described here. This procedure has the added benefits that the user is reminded every 10 minutes by two short beeps that the Alarm needs to be replaced and that if the problem clears the Alarm will return to detecting fire). Pressing the test button again will silence the Alarm for a further 8 hours.

### 12.2.3. Faulty smoke chamber

In the unlikely event of the smoke sensing chamber becoming defective, the Alarm will give 2 short beeps with 2 yellow LED flashes every 32 seconds. The Alarm must then be replaced.

If it is not convenient to replace it immediately, press the test button. The yellow LED will flash rapidly while the test button is held. Release the test button, this will silence the beeps and stop the yellow LED flashing for 12 hours. This can be repeated as required.

## 12.3. Diagnostic Modes

During annual maintenance and service authorised personnel can use the very useful diagnostic modes to investigate if there have been previous alarm conditions, identify a Alarm with a fault condition and predict fault conditions that are likely to manifest themselves before the next annual service.

### 12.3.1. Predictive failures

Pressing and holding the test button will indicate if there is likely to be a low battery or contaminated chamber fault before the next annual visit. The yellow LED will flash rapidly and the alarm will ramp to full sound in the event of a potential low battery fault. In the case of a potential contaminated chamber fault, the yellow and red LEDs will flash alternately and the Alarm will ramp to full sound. If the yellow and red LEDs flash alternately and the Alarm does not sound then the Alarm has reached its end of life - this can be verified by checking the date code label also.

To avoid a call out before the next annual service we recommended the Alarm be replaced.

### 12.3.2. Alarm Memory function

If there has been an alarm condition in the last 24 hours the red LED will flash twice every 16 seconds. An alarm condition outside of the previous 24 hours can be checked by pressing and holding the test button, the red LED will flash every 0.5 seconds and the sounder will chirp rapidly.

### 12.3.3. Identifying faulty Alarms

To identify a beeping Alarm in your system, press and hold the test button of each Alarm. In the faulty Alarm the yellow LED will flash rapidly to indicate a smoke chamber fault. In the case of a low battery fault, the yellow LED will flash rapidly and the Alarm will ramp to full sound. For either of these conditions the Alarm should be replaced.

## 12.4. AudioLINK

AudioLINK is an added feature available in the Ei650i series only. This feature allows an authorised person to download information from the Alarm through the use of a mobile App. For more information on using this feature, please refer to the relevant section on [www.eielectronics.com](http://www.eielectronics.com).

The crossed out wheelie bin symbol that is on your product indicates that this product should not be disposed of via the normal household waste stream. Proper disposal will prevent possible harm to the environment or to human health. When disposing of this product please separate it from other waste streams to ensure that it can be recycled in an environmentally sound manner. For more details on collection and proper disposal, please contact your local government office or the retailer where you purchased this product.





0786

Ei Electronics, Shannon, Co. Clare, Ireland

11

DoP No.13-0002

EN14604:2005 + AC:2008

Smoke Alarm Devices:

Ei650, Ei650C, Ei650W, Ei650RF, Ei650i, Ei650iC, Ei650iW, Ei650iRF

Fire Safety

Nominal activation conditions/ sensitivity, response delay (response time) and performance under fire condition	<b>Pass</b>	Vibration resistance	<b>Pass</b>
Operational reliability	<b>Pass</b>	Humidity resistance	<b>Pass</b>
Tolerance to voltage supply	<b>Pass</b>	Corrosion resistance	<b>Pass</b>
Response delay and temperature resistance	<b>Pass</b>	Electrical stability	<b>Pass</b>

The Declaration of Performance No. 13-0002 may be consulted at [www.eielectronics.com/compliance](http://www.eielectronics.com/compliance)

## 14. Contact Us

**Aico Ltd.** Mile End Business Park, Maesbury Rd, Oswestry,  
Shropshire SY10 8NN, U.K. Tel: 01691 664100

**[www.aico.co.uk](http://www.aico.co.uk)**

**Ei Electronics.** Shannon, Co Clare, Ireland. Tel: 061 471277

**[www.eielectronics.com](http://www.eielectronics.com)**



# RadioLINK<sup>+</sup> Module Ei600MRF for Battery Powered Smoke / Heat Alarms Ei600 Series



Ei600MRF Module

(for use with Ei600 Series compatible Alarms only)



## Instructions

Read and retain carefully for as long as the product is being used. It contains vital information on the operation and installation of your Module. The leaflet should be regarded as part of the product.

If you are just installing this Module, the leaflet must be given to the householder. The leaflet is to be given to any subsequent user.

## Table of Contents

	page
Introduction .....	3
Compatibility Table .....	4
Installation and House Coding .....	5
Additional Features .....	7
Indicator Summary .....	9
System Examples .....	10
Testing the system .....	12
Interconnected Smoke/Heat Alarms & Carbon Monoxide Alarms ...	14
RadioLINK <sup>+</sup> Troubleshooting .....	15
Technical Specifications .....	16
Guarantee .....	17
Limitations of Radio Communications .....	18

## Introduction

The Ei600MRF RadioLINK+ Module is the next generation RF module designed to fit in the Ei600 series Smoke/Heat Alarms. The Ei600MRF RadioLINK+ Module is a direct replacement for the Ei650M RadioLINK module, but now with added features.

The primary function of the Ei600MRF is to interconnect all Ei Electronics Alarms in a system by the means of an RF signal i.e. when one Alarm senses a fire event, the Ei600MRF module attached to that alarm will transmit an RF signal that will activate the sounders in all the other Alarms in the system.

The Ei600MRF module is plugged into the rear of the base of an Ei Electronics compatible Alarm (see Compatibility Table on page 4). RF communication through this module eliminates the need to install long interconnect wires between all the Alarms on different floors in different rooms. The Ei600MRF is powered from its own 3V Lithium battery.

The module also has “multiple repeater” transmission – this provides multiple signal paths to create a robust RF ‘mesh’ system and also increase the RF range.

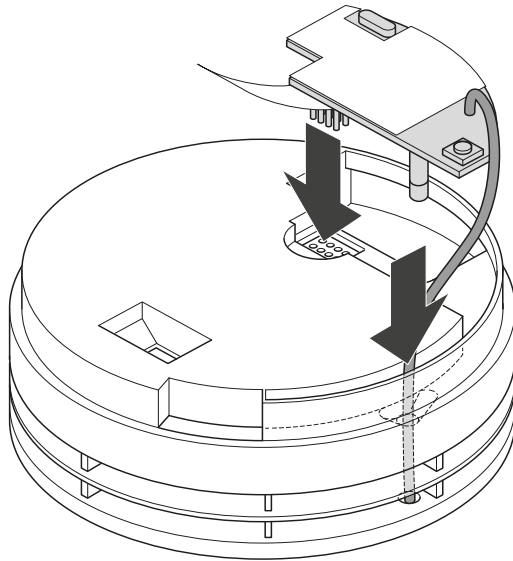
## Compatibility Table

<b>Standard Smoke Alarms</b>			
<b>Model</b>	<b>Hardwired Interconnect</b>	<b>RF <sup>1</sup> Capability</b>	<b>Compatible with Ei600MRF</b>
<b>Ei605TYC</b>	<b>Yes</b>	<b>Yes</b>	<b>No<sup>2</sup></b>
<b>Ei650</b>	<b>No</b>	<b>No</b>	<b>No</b>
<b>Ei650C</b>	<b>Yes</b>	<b>Yes</b>	<b>Yes</b>
<b>Ei650W</b>	<b>No</b>	<b>Yes</b>	<b>Yes</b>
<b>Intelligent Smoke Alarms</b>			
<b>Model</b>	<b>Hardwired Interconnect</b>	<b>RF <sup>1</sup> Capability</b>	<b>Compatible with Ei600MRF</b>
<b>Ei650i</b>	<b>No</b>	<b>No</b>	<b>No</b>
<b>Ei650iC</b>	<b>Yes</b>	<b>Yes</b>	<b>Yes</b>
<b>Ei650iW</b>	<b>No</b>	<b>Yes</b>	<b>Yes</b>
<b>Heat Alarms</b>			
<b>Model</b>	<b>Hardwired Interconnect</b>	<b>RF <sup>1</sup> Capability</b>	<b>Compatible with Ei600MRF</b>
<b>Ei603TYC</b>	<b>Yes</b>	<b>Yes</b>	<b>Yes</b>

1. Certain Alarms may be supplied (on request) with the appropriate RF module fitted
2. Ei605TYC is compatible with Ei605MTYRF only

## Installation and House Coding

To fit the Ei600MRF module, plug it into the base of the compatible Alarm while being careful to align the pins and insert the flexible antenna into the antenna hole (See Fig 1). N.B. Ensure that the Ei600MRF is fully inserted.



**Figure 1**

### House Coding the Unit

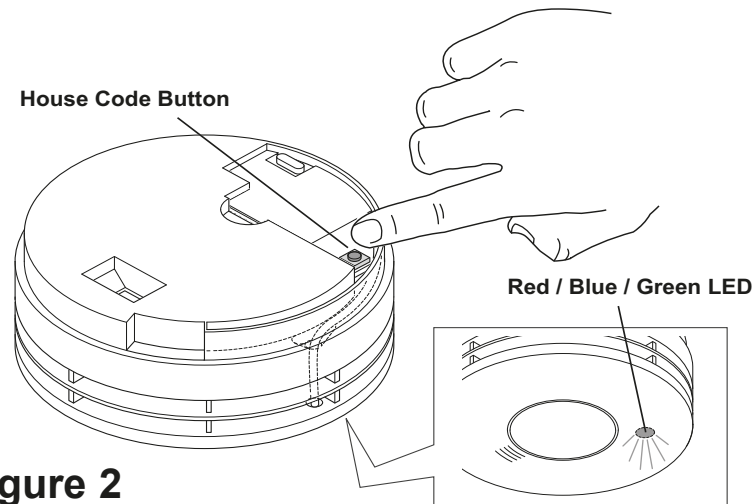
Power supply to the Ei600MRF will be confirmed by an initial flash of the red, blue and green LED on the cover (see Fig 2).

Press and hold the House Code button on the module until the blue light illuminates on the cover. (see Fig 2).

Immediately release the button, the blue light will flash rapidly and then stop. Now attach the Alarm to its mounting plate. (see 'Installation' section in the Ei650 Series booklet).

The flashing will repeat every 5 seconds thereafter. Repeat this procedure for all RF devices in the system.

Check to ensure all RF devices have been successfully House Coded. This can be done by counting the number of blue flashes on each RF Module. The number of flashes should correspond to the number of RF devices in the system. (i.e. 4 flashes if there are 4 RF devices in the system).



**Figure 2**

**N.B. We recommend, for ease of installation and RF communication, that up to 12 RF devices can be installed in any one RF coded system. Please contact us for further advise if additional RF devices are required.**

You can exit this mode by pressing the House Code button on one of the RF Alarms. Keep the button pressed until the blue light comes on solid and then release.

The Alarm will now send a signal to all the other RF devices in the system to exit House Code. Alternatively, the RF devices will automatically exit the House Code mode after 30 minutes. Note: Some RadioLINK devices do not support the on demand exit House Code feature. You may allow them to automatically exit House Code after the time period or if you wish, you can do it manually. Consult the individual RadioLINK device manual for further instructions.

To check the system, press the test button on any Alarm. After a few seconds all Alarms should now sound. All Alarms in the system should be checked similarly.

**Caution:** Do not House Code another group (e.g. adjacent apartment) until the current House Code has been completed.

### **Factory Reset**

Sometimes in order to resolve an RF communication issue it may be necessary to reset (factory reset) and House Code the system again. To do so, press and hold the House Code button until you see a flashing blue light on the Alarm cover (approx. 7 seconds), release immediately. Repeat this procedure on all other Alarms.

## **Additional Features**

The Ei600MRF RadioLINK<sup>+</sup> Module provides additional features not available with Ei Electronics RadioLINK products. The following features will only work with RadioLINK<sup>+</sup> devices.

1. Remote House Coding (required if you want to add an Alarm to an installed system)
2. Monitoring
3. Data Extraction

\*Note these functions will not be available unless you have completed House Code Entry

### **1. Remote House Coding**

If it is necessary to extend an RF system or you find that you want to add an extra Alarm to a system you can now do so quite simply via the 'Remote House Coding' feature. Firstly remove any Alarm in an RF system from its mounting plate and press the House Code button on this device. Hold the button until you see all colours flashing (red, blue, green) and then release. This Alarm will now send an RF message to all the previously installed (compatible) devices to re-enter House

Code mode. Similarly, install and put the new Alarm you wish to add to the system into House Code mode (see “Installation and House Coding” section). As before, allow sufficient time so that all Alarms are now house coded correctly (this can be confirmed by counting the number of flashes on each Alarm). You can then exit House Code mode manually or let it exit automatically after 30 minutes. **(N.B. for this feature to work all devices in the system must be RadioLINK+).**

## **2. Monitoring**

The Ei600MRF RadioLINK+ Module has the ability to “Monitor” the RF signal path and strength. This is an enhanced self-monitoring function that recognises system tampering or Alarm head removal. In monitoring mode each Alarm will check the presence of its strongest received RF signal. If the signal is missing then the Alarm will record a monitoring failure event. It will also signal the failure via a change in the indicator light pattern.

For more information on using this feature, please visit [www.eielectronics.com](http://www.eielectronics.com) and refer to the relevant section on the RadioLINK+ Monitoring feature.

## **3. Data Extraction**

The Ei600MRF RadioLINK+ Module allows for the extraction of information from an Ei Electronics Compatible Alarm, using an Ei Electronics download device. Once the system has been set up, information can be accessed securely from within or outside a property if access is an issue. The event log can contain very useful information about any recorded events in the history of the Alarm such as: Fire Events, Alarm Head removals, Button Tests, and so on.

Event logs can be retrieved as many times as necessary.



## Ei600MRF Indicator Summary

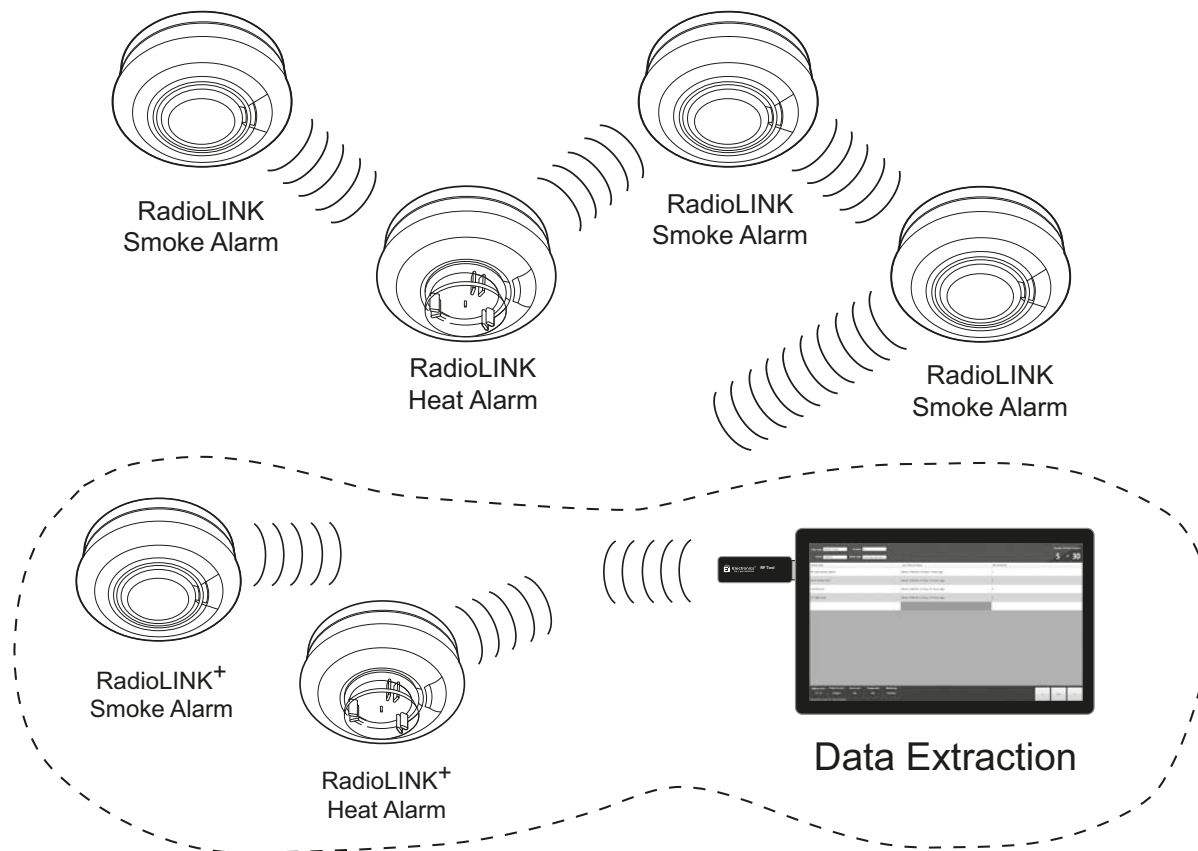
Ei600MRF Indicator Summary					
Normal Operation		Blue LED	Red LED	Green LED	Sounder
Power Up		1 flash	1 flash	1 flash	Off
Standby		Off	Off	Off	Off
Alarm		3.5 Sec flash followed by flash every 10 Sec	Off	Off	Full Sound
Head Removal		3.5 Sec flash every 6 mins for 4 hrs	Off	Off	Off
Low Battery (Ei603TYC)*		Flash every 60 Sec	Off	Off	Off
Low Battery (Ei650C / W / iC / iW)*		Flash every 60 Sec	Off	Off	1 beep with flash
Mode-Enter / Exit	Button Action	Blue LED	Red LED	Green LED	Sounder
House Code Enter	Press & Release on Solid Blue	Flashes briefly & stops	Off	Off	Off
In House code		(1 flash per unit) every 5 Sec**	Off	Off	Off
House code Exit	Press & Release on Solid Blue	3.5 Sec flash	Off	Off	Off
Factory Reset	Press & Release on Flashing Blue	Rapid flashing followed by single flash	Off	Off	Off
Remote House Coding	Press & Release on Multi- Colour Flashing	Rapid flashing followed by 3.5 Sec flash	Off	Off	Off

\* Ei600MRF Low Battery indicators when installed in these Alarms

\*\* See 'Installation and House Coding' section for further details

# System Examples

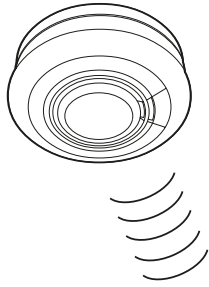
## RF System (RadioLINK & RadioLINK<sup>+</sup>)



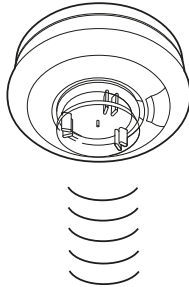
Note: Remote House Coding / Monitoring / Data Extraction only available on RadioLINK<sup>+</sup> Alarms

# RadioLINK+ System

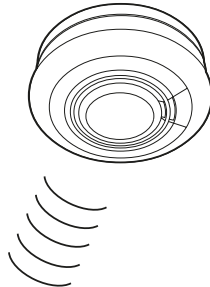
RadioLINK+  
Smoke Alarm



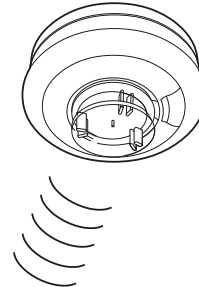
RadioLINK+  
Heat Alarm



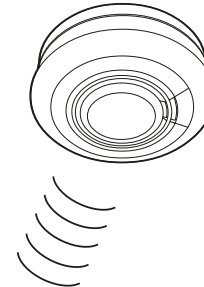
RadioLINK+  
Smoke Alarm



RadioLINK+  
Heat Alarm



RadioLINK+  
Smoke Alarm



Data Extraction

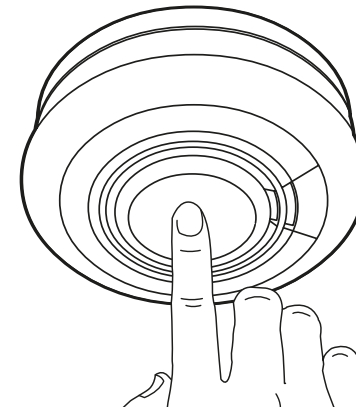
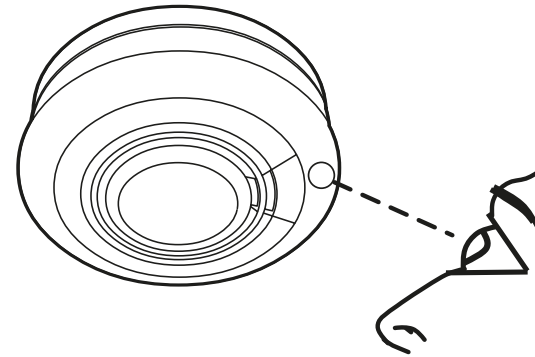
## Testing the System

Frequent testing of the system is a requirement to ensure its reliable operation. Guidelines and best practices for testing are as follows:

1. After the system is installed.
2. Regularly (monthly testing is recommended).
3. After prolonged absence from the dwelling (e.g. after holiday period).
4. After repair or servicing of any of the components.
5. After renovations to the house.

To test an individual Alarm press and hold the test button until the horn sounds. This ensures that the Alarm is powered and that the circuit is functioning correctly.

To test the RadioLINK<sup>+</sup> system, press and hold the test button on one of the Alarms. The blue LED from the Ei600MRF will illuminate for approximately 3.5 seconds. Continue to hold the test button until all the Alarms in the system are sounding. This will take a few seconds depending on the number of Alarms and their locations in the system, e.g. a system with 12 Alarms may take up to 45 seconds for them all to sound. Release the test button when the test is completed.



The local Alarm will stop sounding but you will hear the other Alarms still sounding in the distance. All Alarms should be checked in a similar way.

### Module Battery Check

It is important to ensure that the batteries on both the Alarm and the module itself are in full working order. Depending on the Alarm that the Ei600MRF is inserted to, there will be slightly different indicators for low battery on the Alarm itself (see table below).

**N.B.** Press the test button on each Alarm and check that all the Alarms sound.

Low Battery Indicator Table		
Alarm Model	Module Low Battery	Alarm Low Battery
Ei603TYC	1 blue flash with <b>no</b> beep every 60 sec	1 beep every 40 sec with <b>no</b> flash
	2 sec alarm every 4 hours	
Ei650W / 650C	1 blue flash with a beep every 60 sec	1 beep every 32 sec with a red LED flash
	1 beep every 4 hours	
Ei650iW / 650iC	1 blue flash with a beep every 60 sec	1 beep every 32 sec with a yellow LED flash
	1 beep every 4 hours	

In each of these cases you should replace either the Alarm or the module depending on the low battery condition.

## **Beeping in RF System**

One of the features of Ei RadioLINK & RadioLINK<sup>+</sup> systems is that if there is a fault either in the Alarm itself, or in the RF module fitted, a beep will be transmitted around the system every 4 hours. Depending on the Alarm type, the beep may just be a short beep or it may be a 2 second alarm. If your RF system is demonstrating this, you have a fault either in 1 of your Alarms or in 1 of the RF modules fitted.

In order to find the problem unit, please visually check each Alarm. The fault will be indicated on the Alarm through a combination of beeps or flashes within a 60 second period. (see individual Alarm booklet for indicators).

N.B. When replacing Alarms or modules, please remember to housecode and test the system again.

## **End of Life (EOL) Check**

Check the 'replace by date' label on all Ei600MRF modules and attached Alarms. If the date has been exceeded then the device should be replaced.

## **Interconnected Smoke/Heat Alarms & Carbon Monoxide Alarms**

### **Identifying source of Alarm**

Ei Electronics Smoke/Heat Alarms and Carbon Monoxide Alarms can be interconnected via RadioLINK or RadioLINK<sup>+</sup> so that one device sensing danger will cause all the other Alarms to sound.

When a system sounds, check to see which device has its red light flashing rapidly - this is the source of the alarm.

If it is a Smoke/Heat Alarm, evacuate the residence and follow the instructions in the Smoke/Heat Alarm manual.

If it is a Carbon Monoxide Alarm, ventilate the residence and follow the instructions in the Carbon Monoxide Alarm manual.

For added convenience we recommend that an Ei450 Alarm Controller is used with these systems. When there is an alarm, an icon on the Ei450 Alarm Controller shows if it is a Fire or CO incident and can be remotely controlled accordingly.

## **RadioLINK<sup>+</sup> Troubleshooting**

It is important that all Alarms in your system communicate with each other. The number of walls, ceilings and metal objects in the signal path will reduce the strength of the RadioLINK<sup>+</sup> signals between the Alarms. Accordingly, one or more CO/Smoke/Heat Alarms may have difficulties in communicating to all the other Alarms in the system.

If, when checking the RadioLINK<sup>+</sup> interconnection, some of the Alarms do not respond to the button test, then you will need to either:

(i) Position another RadioLINK<sup>+</sup> Alarm to act as a 'repeater' between the Alarms which are not communicating and so shorten the path and/or by-pass an obstacle which is blocking the signal. When the new Alarm is fitted, House Code all Alarms again, as described above.

(ii) rotate / re-locate the Alarms (e.g. move them away from metal surfaces or wiring).

After making these changes to the RF signal path, the RadioLINK<sup>+</sup> signals may still not be reaching all the Alarms in your system, even though they have already been House Coded successfully. (see Section on "Limitations of Radio Communications").

It is important to check that all Alarms are communicating in their final installed positions. If Alarms are rotated, have had their antennas extended and/or re-sited, we would recommend that all the Alarms are returned to the factory settings and then House Coded again in their final positions (see above). The RadioLINK<sup>+</sup> interconnection should then be checked again by button testing all units.

(Note: The RadioLINK<sup>+</sup> module can be returned to the originally factory settings by pressing and holding the House Code switch until the blue light flashes and then releasing. This will take about 7 seconds. This clears the House Codes that have been learnt).

## Technical Specifications

<b>Supply Voltage:</b>	3V internal lithium battery (non-replaceable)
<b>RF Range:</b>	A minimum of 100 metres in free space
<b>RF Visual Indicator:</b>	Blue light flashes continuously for 0.5 to 3.5 seconds while transmitting RF signal
<b>RF Frequency:</b>	868.499MHz (1% duty cycle)
<b>Max RF Power:</b>	+10dBm
<b>Dimensions:</b>	57mm length x 30mm depth x 18mm height
<b>Temperature Range:</b>	0° to 40°C
<b>Humidity Range:</b>	15% to 95% Relative Humidity (non-condensing)
<b>Interconnect *:</b>	Up to 12 RadioLINK <sup>+</sup> or RadioLINK modules



- Optional Accessories:**
- Ei407 Manual Call Point
  - Ei428 Relay Module
  - Ei414 Fire / CO Alarm Interface
  - Ei450 RadioLINK Alarm Controller

**Approvals:** RF performance to EN 300 220-1 in accordance with EN 300 220-2  
EMC performance to EN 301 489-1 in accordance with EN 301 489-3

\* We recommend, for ease of installation and RF communication, that up to 12 RF devices can be installed in any one RF coded system. Please contact us for further advise if additional RF devices are required.

## Guarantee

Ei Electronics guarantees this RF RadioLINK<sup>+</sup> Module for five years from date of purchase against any defects that are due to faulty materials or workmanship. This guarantee only applies to normal conditions of use and service, and does not include damage resulting from accident, neglect, misuse, unauthorised dismantling, or contamination howsoever caused. This guarantee excludes incidental and consequential damage. If this RF RadioLINK<sup>+</sup> Module should become defective within the guarantee period, it must be returned to Ei Electronics, with proof of purchase, carefully packaged, with the problem clearly stated. We shall at our discretion repair or replace the faulty unit.

Do not interfere with the Alarm or attempt to tamper with it. This will invalidate the guarantee, but more importantly may expose the user to shock or fire hazards. This guarantee is in addition to your statutory rights as a consumer.

## Limitations of Radio Communications

Ei Electronics radio communication systems are very reliable and are tested to high standards. However, due to their low transmitting power and limited range (required by regulatory bodies) there are some limitations to be considered:


- (i) Receivers may be blocked by radio signals occurring on or near their operating frequencies, regardless of the House Coding.
- (ii) Alarms with RadioLINK<sup>+</sup> modules should be tested regularly, at least monthly. This is to determine whether there are sources of interference preventing communication, that the radio paths have not been disrupted by moving furniture or renovations, and if so, to give a warning of these and other faults.



Hereby, Ei Electronics declares that this Ei600MRF RadioLINK<sup>+</sup> Module is in compliance with the essential requirements and other relevant provisions of Directive 2014/53/EU. The Declaration of Conformity may be consulted at [www.eielectronics.com/compliance](http://www.eielectronics.com/compliance)

The crossed out wheelee bin symbol that is on your product indicates that this product should not be disposed of via the normal household waste stream. Proper disposal will prevent possible harm to the environment or to human health. When disposing of this product please separate it from other waste streams to ensure that it can be recycled in an environmentally sound manner. For more details on collection and proper disposal, please contact your local government office or the retailer where you purchased this product.





**Aico Ltd.** Mile End Business Park, Maesbury Rd, Oswestry,  
Shropshire SY10 8NN, U.K.

Tel: 01691 664100

**[www.aico.co.uk](http://www.aico.co.uk)**

**Ei Electronics.** Shannon, Co Clare, Ireland. Tel: 061 471277

**[www.eielectronics.com](http://www.eielectronics.com)**

